

# HSF RoHS

REV	ECN NO	DESCRIPTION	DATE	NAME
A		NEW		

Note:

1.Material

- 1.1: Housing: LCP UL94V-0 Color:Nature.
- 1.2: Contact: Phosphor Bronze.
- 1.3: LEG: Phosphor Bronze.

2.Plating

- 2.1: Contact: Tin.
- 2.2: LEG: Tin

3.Rating:

- 3.1: Operating Voltage: 125V AC/DC.
- 3.2: Current Rating: 1A AC/DC.
- 3.3: Operating Temperature: -25°C~+85°C.
- 3.4: Contact Resistance:30 mΩ max.
- 3.5: nsulation Resistance:100 MΩ min.
- 3.6: Dielectric withstanding Voltage: AC 250V
- 3.7:Applicable Wire:AWG#28~#32

4.Pater Number:

PIN	DIM=A	DIM=B	DIM=C	DIM=D
2	1.25	3.05	7.3	7.2
3	2.5	4.30	8.55	8.45
4	3.75	5.55	9.8	9.7
5	5.0	6.80	11.05	10.95
6	6.25	8.05	12.30	12.20
7	7.5	9.30	13.55	13.45
8	8.75	10.55	14.8	14.7
9	10.0	11.80	16.05	15.95
10	11.25	13.05	17.30	17.20
11	12.5	14.30	18.55	18.45
12	13.75	15.55	19.8	19.7
13	15.0	16.80	21.05	20.95
14	16.25	18.05	22.3	22.2
15	17.5	19.30	23.55	23.45
16	18.75	20.55	24.8	24.7
17	20.00	21.80	26.05	25.95
18	21.25	23.05	27.3	27.2
19	22.50	24.30	28.55	28.45
20	23.75	25.55	29.8	29.7

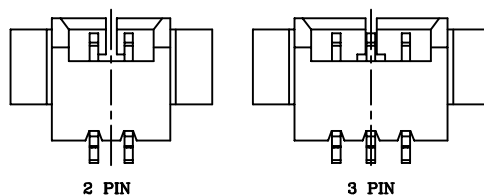
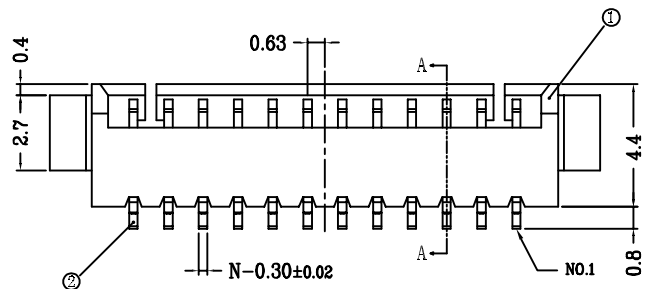
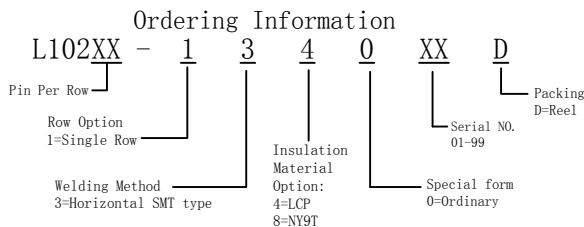
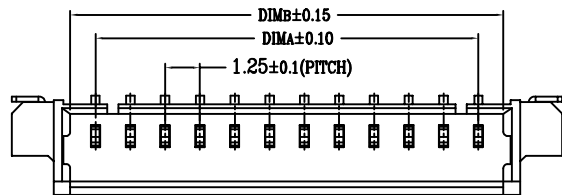

LOCK CONFIGURATION

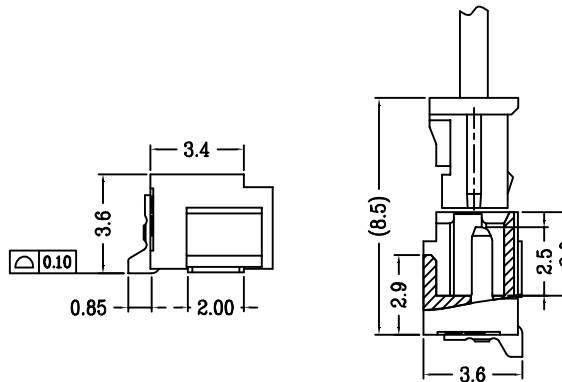
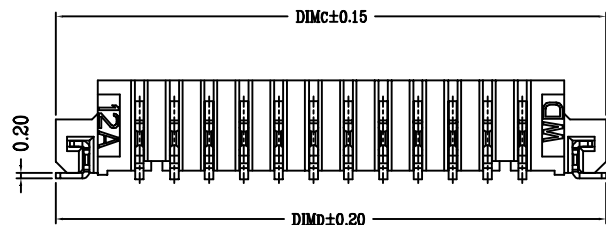

SECTION A-A

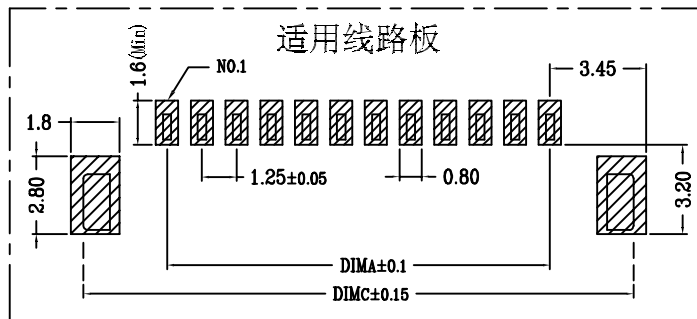

STANDARD TOLERANCE (EXCEPT SPECIFIED)

LINER	ANGLES
.0 ±0.30	0.° ±3°
.00 ±0.20	.0° ±2°
.000 ±0.10	.00° ±1°

**LDCONN 东莞连大精密制品有限公司**  
**连大 DongGuan LianDa Precision Products Co., LTD**

TITLE	PH1.25mm, Single row, Horizontal SMT type	DRAWN BY	WZG	17.03.30
PART NO	L102XX-1340XXD	CHECKED BY		
DRAWING NO		APPROVED BY		
SCALE	1:1	UNIT	mm	PAGE 1/1
				SIZE A4